

gevel tuinzijde

HWA lozing op grindput

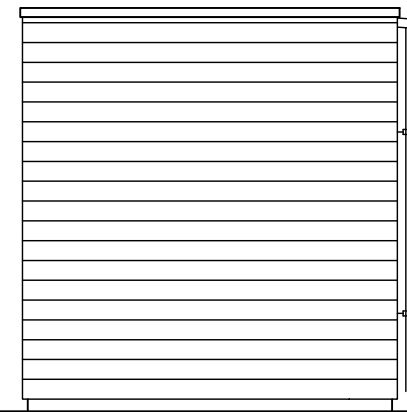

zijgevel Links

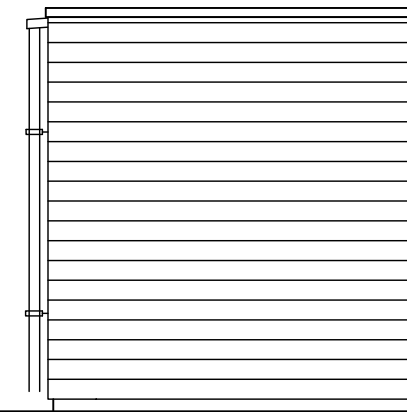

gevel achterpadzijde

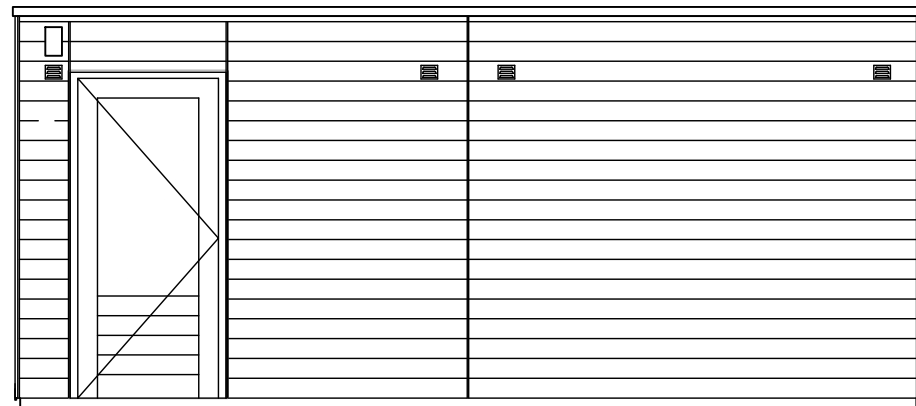

gevel tuinzijde

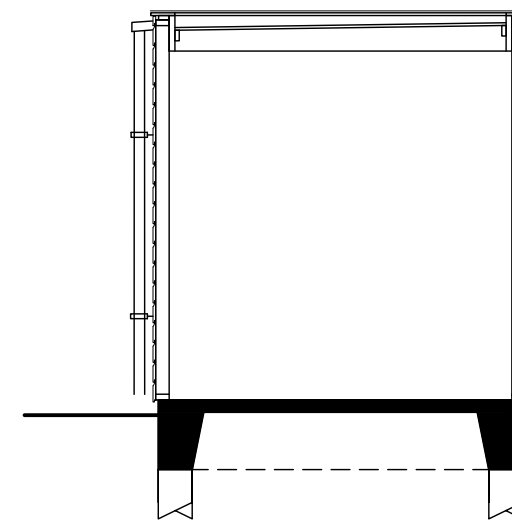
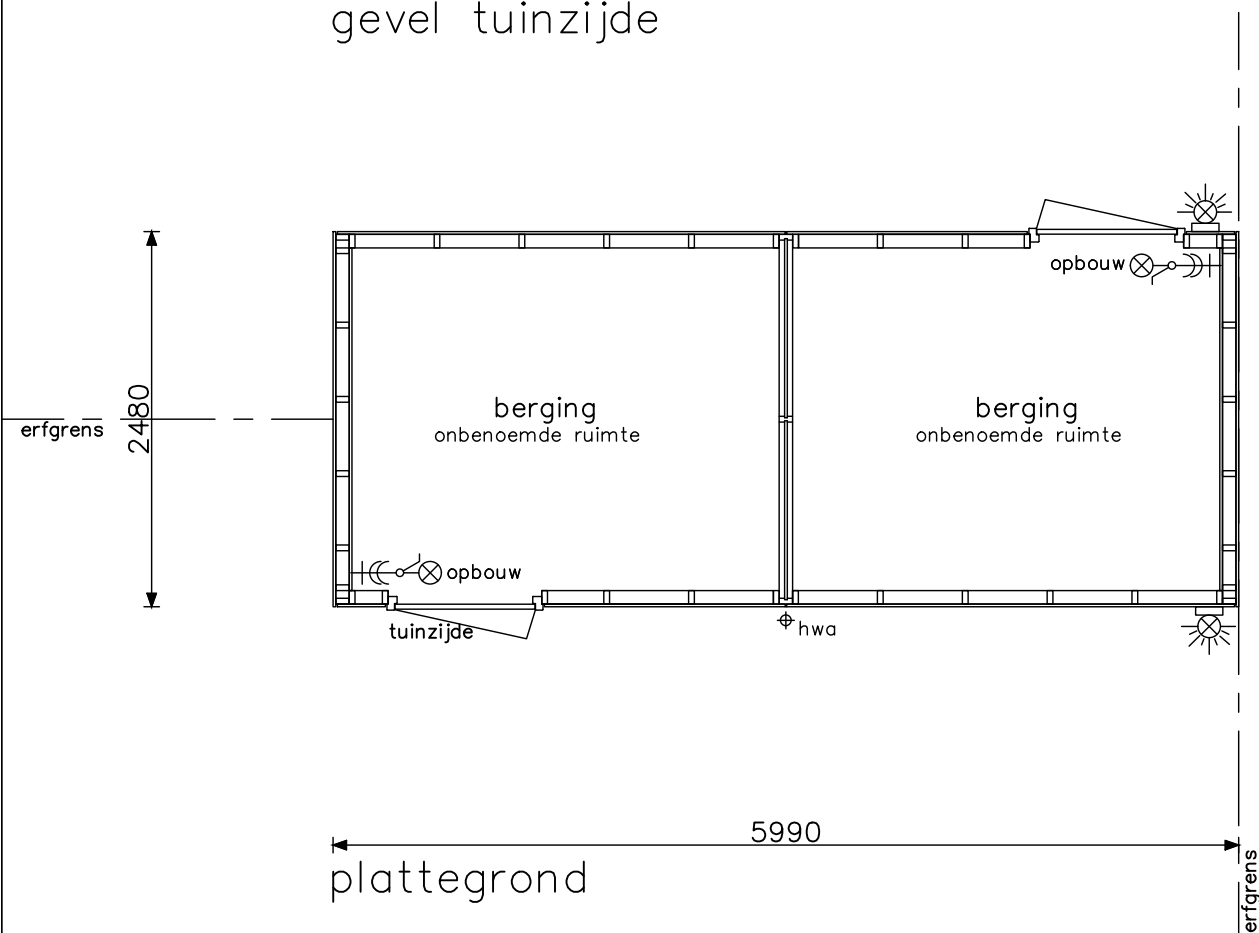

doorsnede "op palen"

Project	36 woningen Parkrijk te Rijswijk
Onderwerp	dubbele berging B2 (hout) plat dak
Schaal	1:50
Tekenaar	MCa
Status	definitief
Projectnr.	8937
Tekeningnr.	V-302B
(wijz)/datum	(-);09-10-2020



berging type B2
bwnrs 116 t/m 121

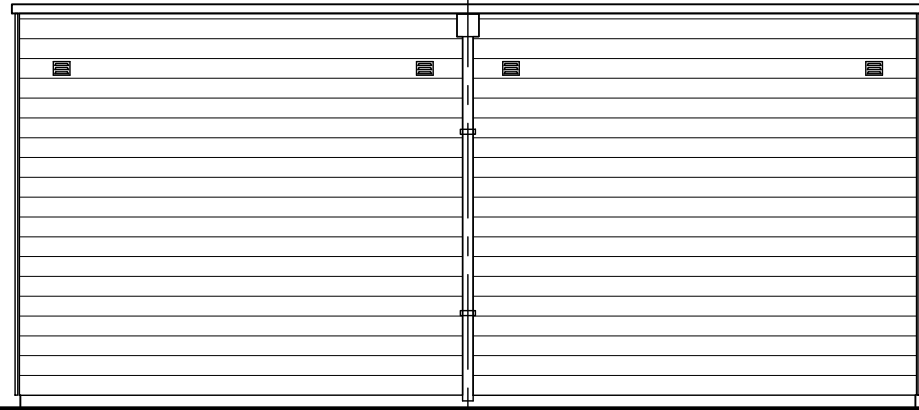

gevel tuinzijde

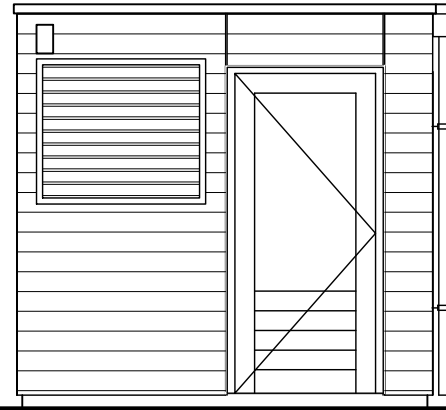

zijgevel

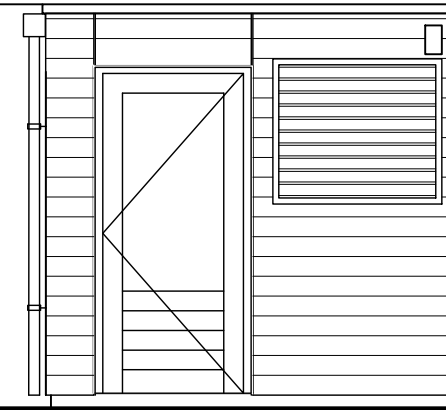

zijgevel

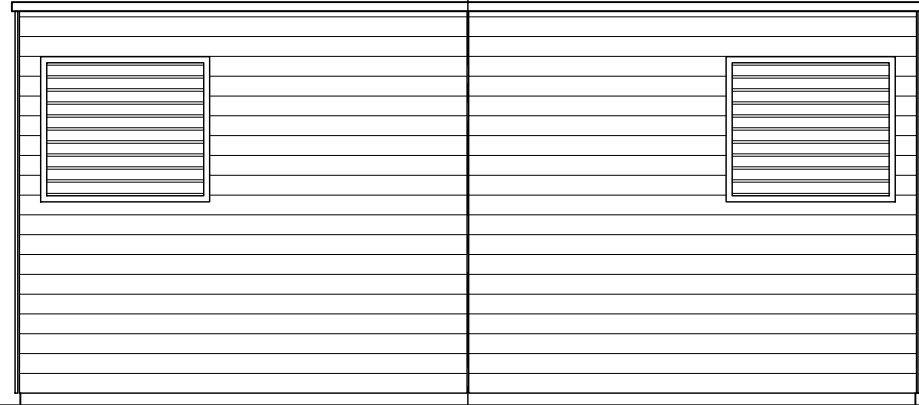

gevel achterzijde

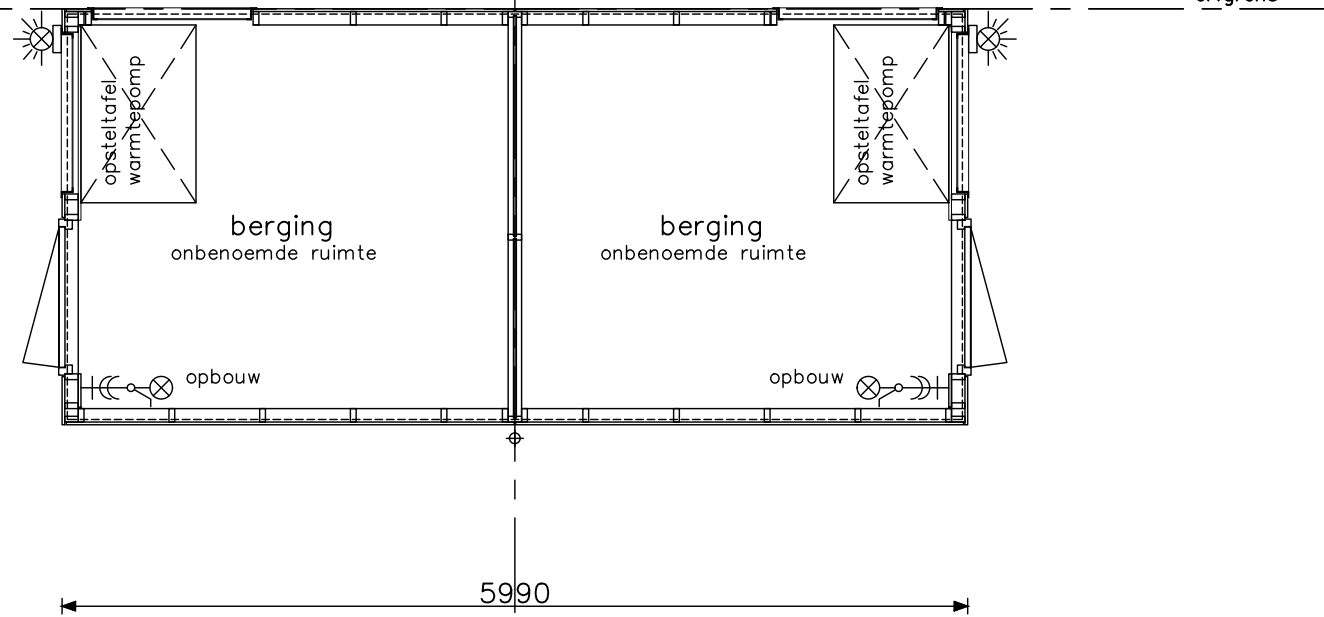

plattegrond

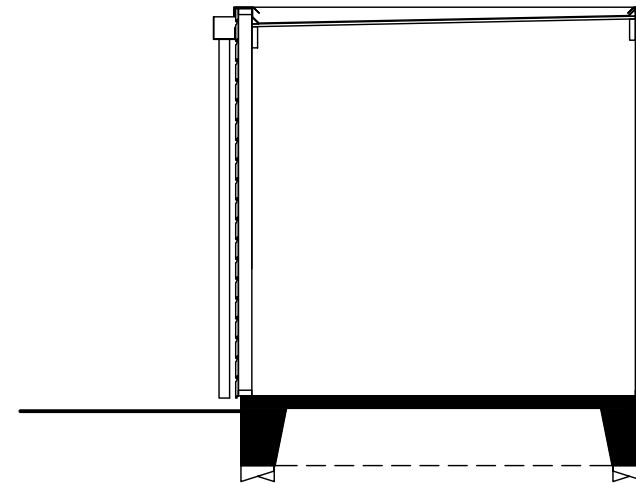

doorsnede "op palen"

Project	36 woningen Parkrijk te Rijswijk
Onderwerp	dubbele berging B3 (hout) plat dak
Schaal	1:50
Tekenaar	MCa
Status	definitief
Projectnr.	8937
Tekeningnr.	V-302C
(wijz)/datum	(-);09-10-2020



berging type B3
bouwnummers 86 t/m 101



gevel tuinzijde

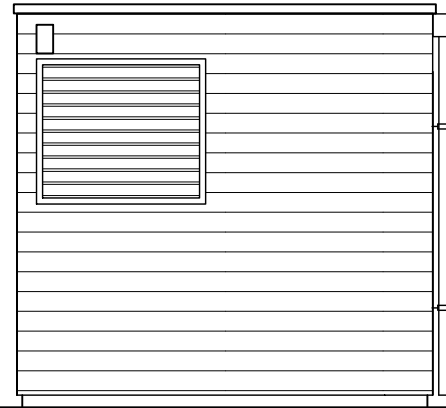

zijgevel

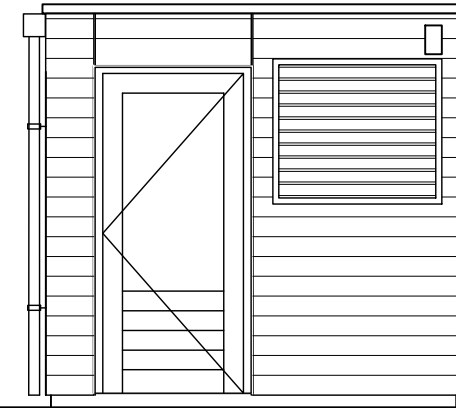

zijgevel

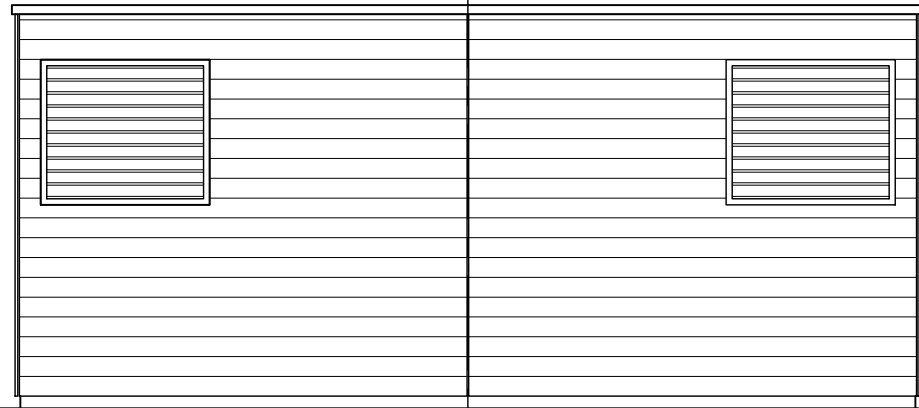

gevel achterzijde

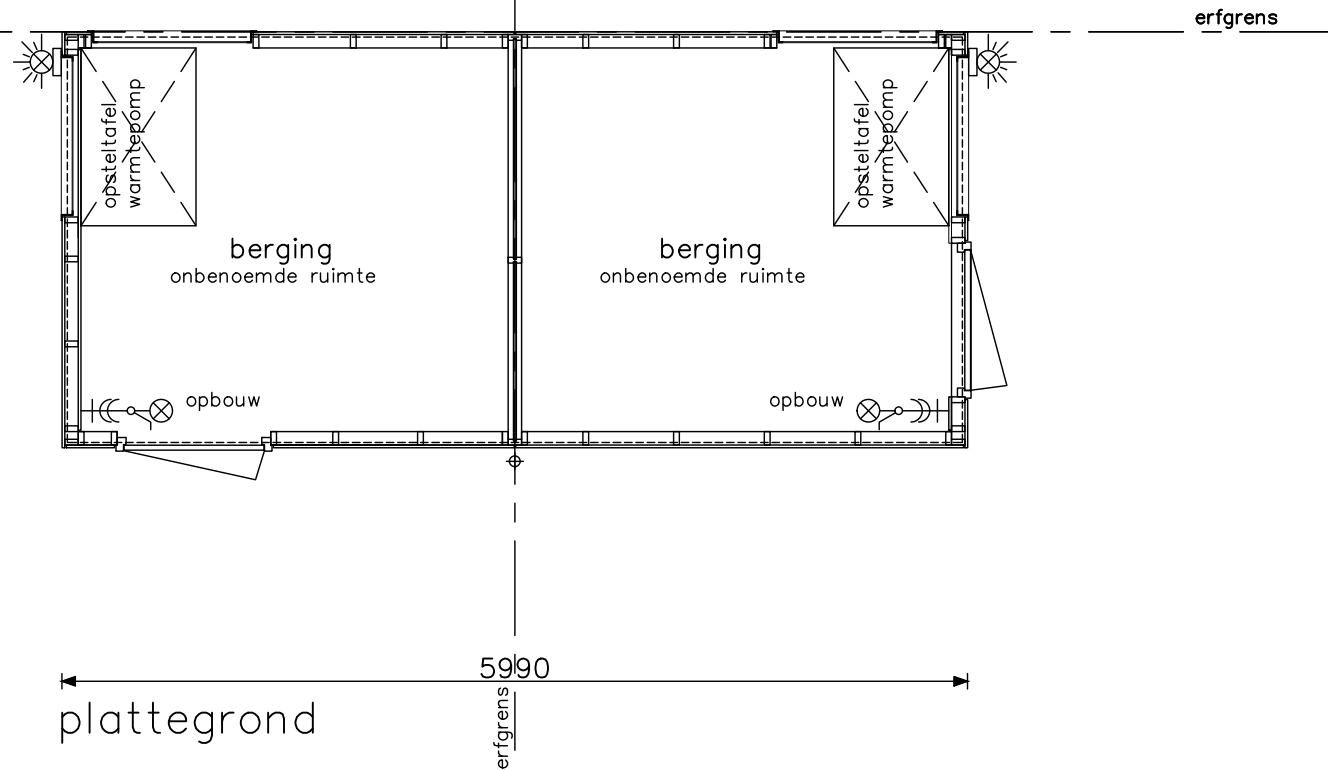

plattegrond

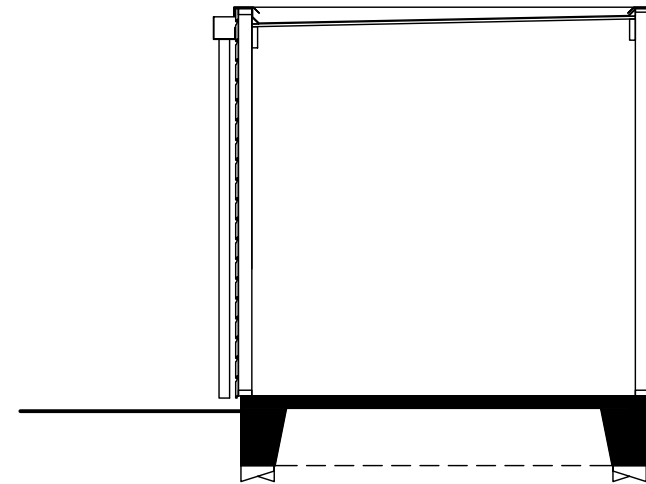

doorsnede "op palen"



berging type B4
bouwnummers 103/102

Project 36 woningen Parkrijk te Rijswijk

projectnr. 8937

tekeningnr.

V-302D

onderwerp dubbele berging B4 (hout)
plat dak

status definitief

tekenaar MCa

schaal 1:50

(wijz)/datum (-):09-10-2020

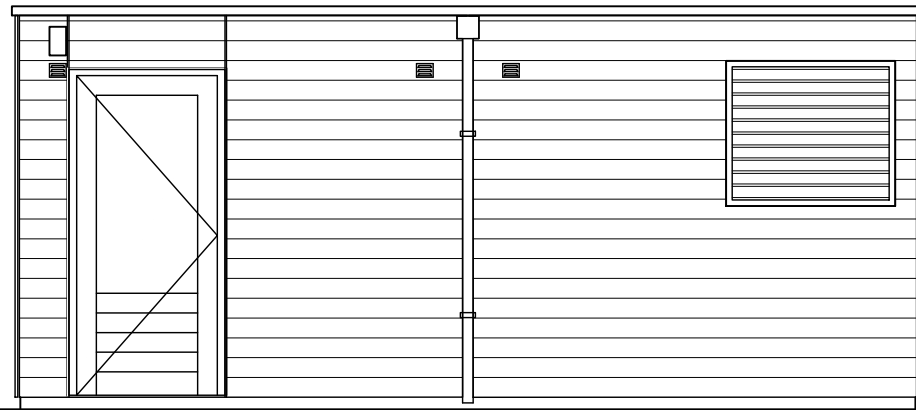

gevel tuinzijde

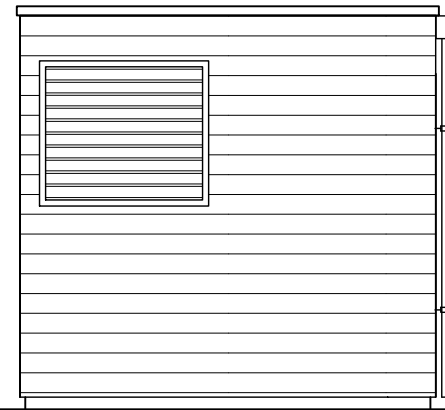

zijgevel

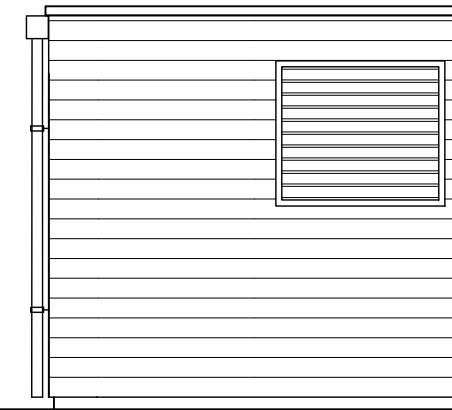

gevel achterpadzijde

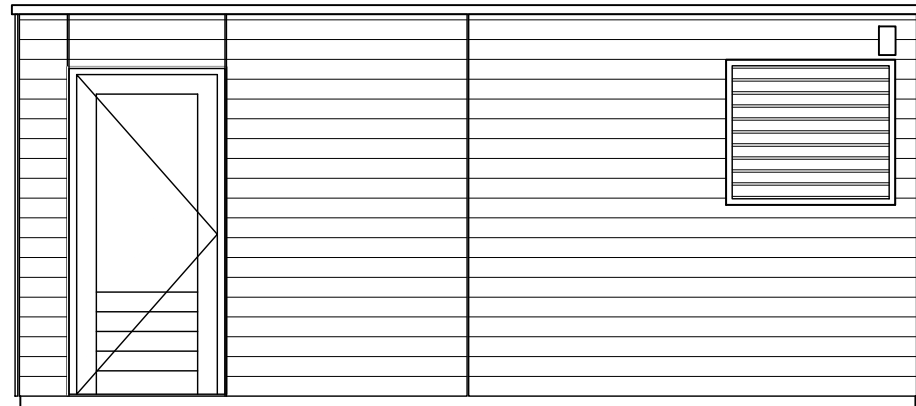

gevel tuinzijde

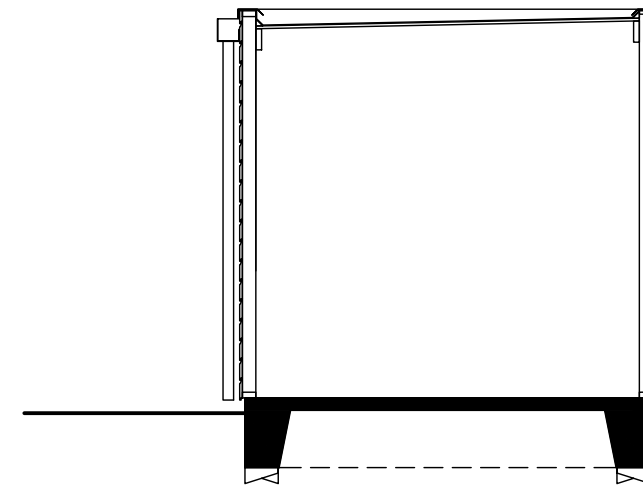
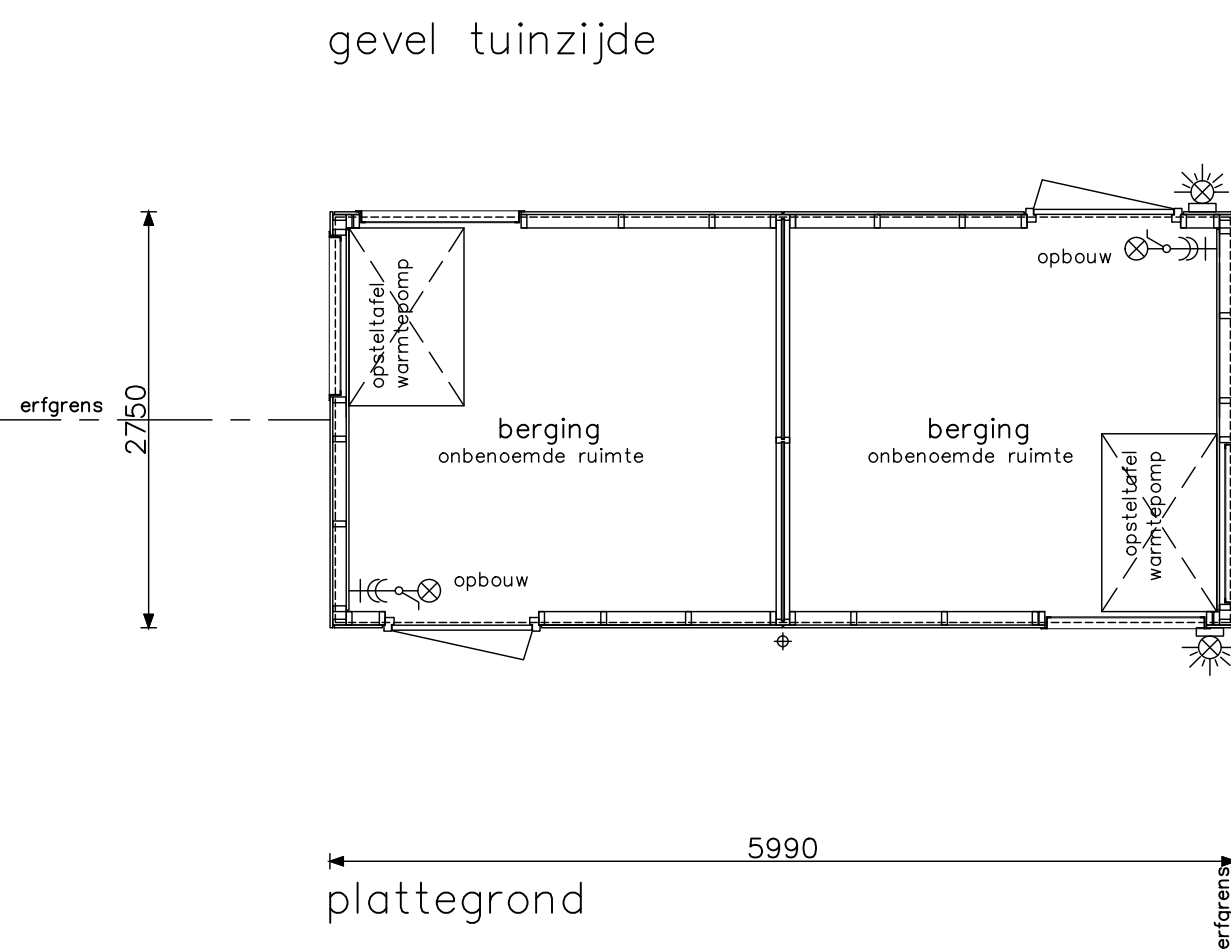

doorsnede "op palen"

Project	36 woningen Parkrijk te Rijswijk
Projectnr.	8937
Onderwerp	dubbele berging B5 (hout) plat dak
Tekeningnr.	V-302E
Schaal	1:50
Tekenaar	MCa
Status	definitief
(wijz)/datum	(-);09-10-2020



berging type B5
bouwnummers 104 t/m 115